

Main Market
(Market ID: M / Venue ID: XATH)
Closing Price: Closing auction
Price Fluctuation Limits: $\pm 30\%$ / $\pm 10\%$
Static Price Range: $\pm 10\%$ / 15% / -
Dynamic Price Range: $\pm 3\%$ / -
Price Tolerance Rule: $\pm 30\%$
Volume Min Rule: 30%
Vol. Int Pre Call: 2min
Vol. Int Extension: 1min
RTP: 1min

Main Market								
Liquidity Class	Market Making	Price	Fluctuation limits	Volatility Interrupters		Closing algorithm		
				Static	Dynamic	Main	Alternative	Closing Reference Price
High	Yes	$\geq 0,05$	$\pm 30\%$	10%	3%	Auction	VWAP of last 30' of trading session	Average trades during time
	No	$\geq 0,05$		10%	3%			
	Yes	$< 0,05$		15%	N/A			
	No	$< 0,05$		15%	N/A			
Middle	Yes	$\geq 0,05$	$\pm 30\%$	10%	3%	Auction	VWAP of last 30' of trading session	Average trades during time
	No	$\geq 0,05$		10%	3%			
	Yes	$< 0,05$		15%	N/A			
	No	$< 0,05$		15%	N/A			
Low	Yes	$\geq 0,05$	$\pm 30\%$	10%	3%	Auction and Significant auction value	Weighted average of a percentage of last trades, based on the transaction value	Last trade price
	No	$\geq 0,05$	$\pm 10\%$	N/A	3%			
	Yes	$< 0,05$	$\pm 30\%$	15%	N/A			
	No	$< 0,05$	$\pm 10\%$	N/A	N/A			

Main Market - Low Dispersion								
Liquidity Class	Market Making	Price	Fluctuation limits	Volatility Interrupters		Closing algorithm		
				Static	Dynamic	Main	Alternative	Closing Reference Price
High or Middle or Low	Yes	$\geq 0,05$	$\pm 10\%$	N/A	3%	Auction and Significant auction value	Weighted average of a percentage of last trades, based on the transaction value	Last trade price
	No	$\geq 0,05$	$\pm 10\%$	N/A	3%	Auction and Significant auction value	Weighted average of a percentage of last trades, based on the transaction value	Last trade price

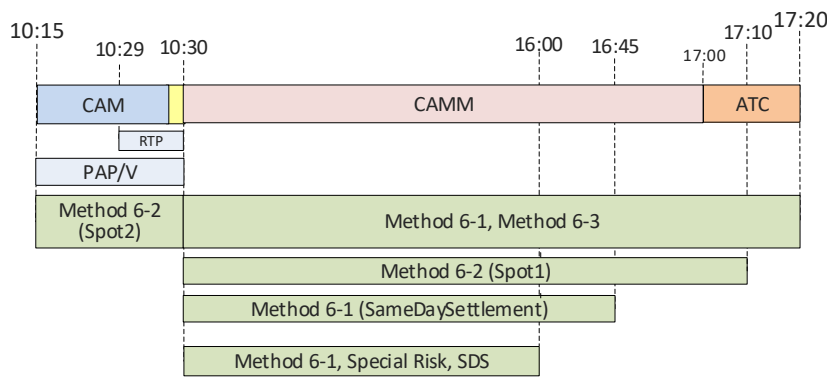

Bonds
(Market ID: O / Venue ID: XATH)
Closing Price: VWAP of last 30' trades
Price Fluctuation Limits: Unlimited
Static Price Range: $\pm 10\%$
Dynamic Price Range: $\pm 3\%$
Price Tolerance Rule: $\pm 30\%$
Volume Min Rule: 30%
Vol. Int Pre Call: 2min
Vol. Int Extension: 1min
RTP: 1min

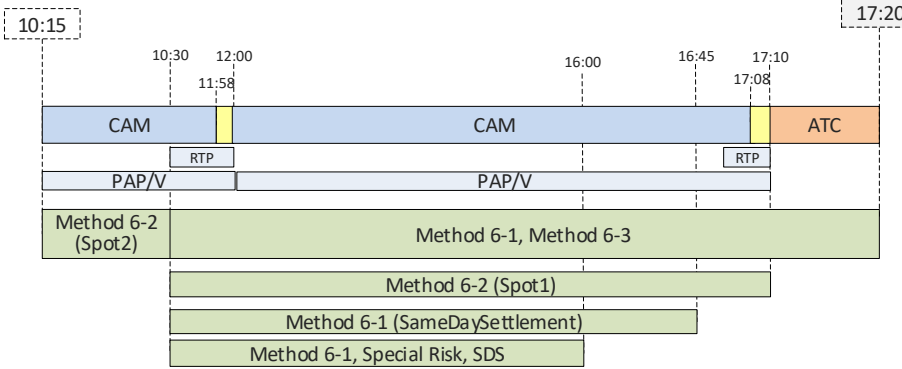

Surveillance (Market ID: C / Venue ID: XATH)
Closing Price: Significant percent of trades
Price Fluctuation Limits: $\pm 10\%$ / $\pm 30\%$

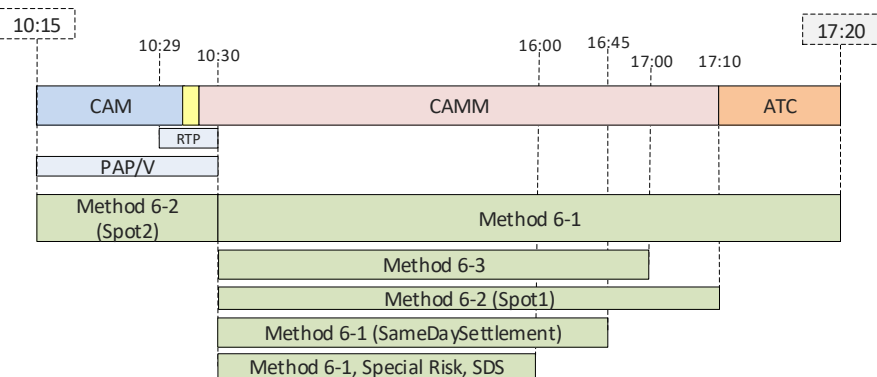

ETF (Market ID: T / Venue ID: XATH)
Closing Price: Last trade price
Price Fluctuation Limits: $\pm 30\%$
Static Price Range: $\pm 10\%$
Dynamic Price Range: $\pm 3\%$
Price Tolerance Rule: $\pm 30\%$
Volume Min Rule: 30%
Vol. Int Pre Call: 2min
Vol. Int Extension: 1min
RTP: 1min

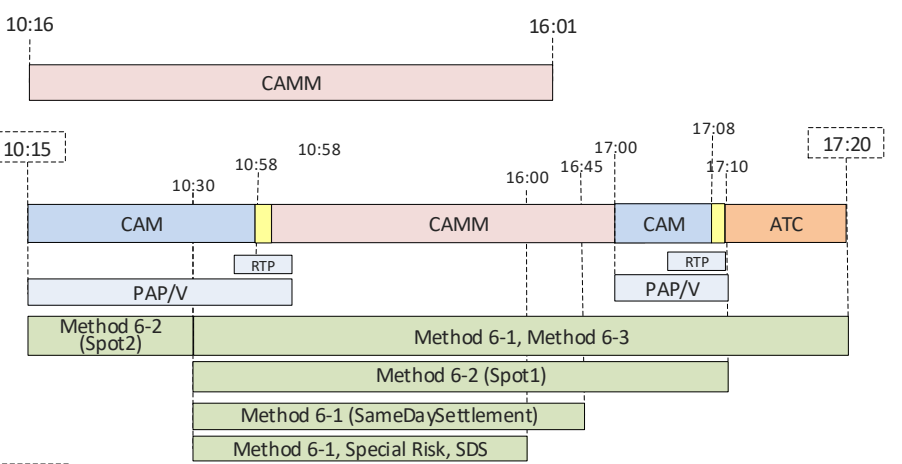

Forced Sales (only for GTB) (Market ID: E / Venue ID: XATH)
Price Fluctuation Limits: Unlimited

Alternative (Market ID: F / Venue ID: ENAX)
Closing Price: Auction and Significant Auction value
Auction Close Method: Weighted Average of a percent of last trades, based on the transaction value
Price Fluctuation Limits: $\pm 10\%$ ($\pm 30\%$ if Market Making is active)
Static Price Range: $\pm 100\%$ ($\pm 10\%$ if Market Making is active)
Dynamic Price Range: $\pm 3\%$
Price Tolerance Rule: $\pm 30\%$
Volume Min Rule: 30%
Vol. Int Pre Call: 2min
Vol. Int Extension: 1min
RTP: 2min

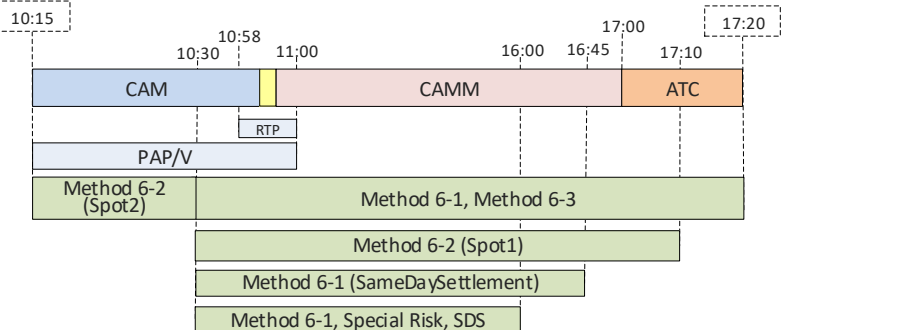

Alternative Bonds (Market ID: G / Venue ID: ENAX)
Closing Price: Weighted average of the last 30' trades
Price Fluctuation Limits: Unlimited
Static Price Range: $\pm 10\%$
Dynamic Price Range: $\pm 3\%$
Price Tolerance Rule: $\pm 30\%$
Volume Min Rule: 30%
Vol. Int Pre Call: 2min
Vol. Int Extension: 1min
RTP: 1min

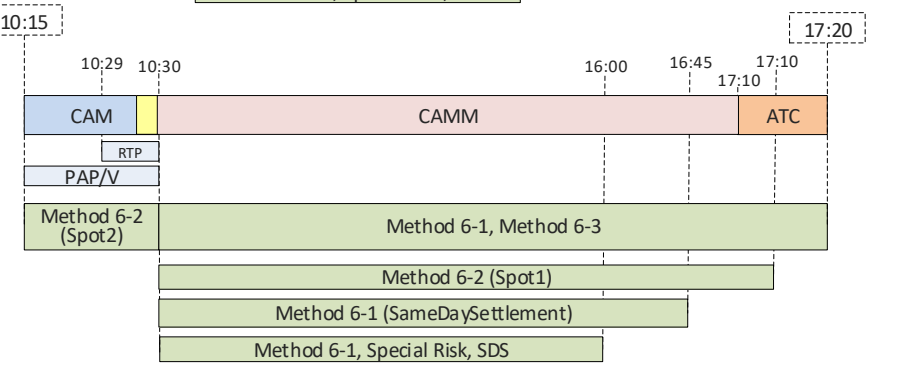

Warrants (Market ID: W / Venue ID: XATH)
Closing Price: Last trade price
Price Fluctuation: $\pm 50\%$, adjusted to $\pm 100\%$, to $+200\%$ and to $+400\%$

Χρονοδιάγραμμα Δεικτών ΧΑ / ATHEX Indices Schedule

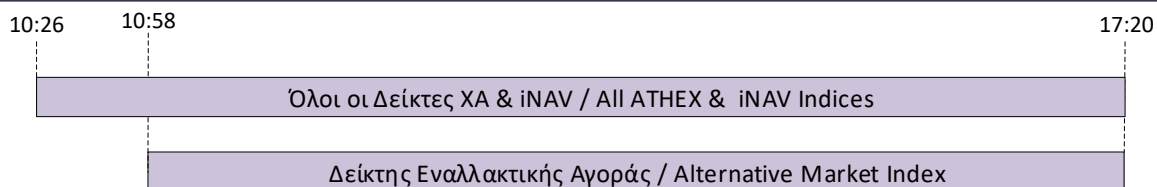

- CAM: Call Auction Method / Μέθοδος Συγκέντρωσης Εντολών και Δημοπρασίας
- CMM: Continuous / Μέθοδος Συγκέντρωσης Εντολών και Δημοπρασίας
- ATC: At The Closing / Μέθοδος Στη Τιμή Κλεισίματος / Μέθοδος Συνεχόμενης Συνεδρίασης
- RTP: Random Time Period / Περίοδος Τυχαίου Χρόνου Δημοπρασίας
- PAP/V: Projected Auction Price/Volume / Υπολογιζόμενη Τιμή / Όγκος Δημοπρασίας

Notes / Σημειώσεις:

Η ενδοημερήσια Δημοπρασία στη Κύρια αγορά πραγματοποιείται μόνο τη 3η Παρασκευή κάθε μήνα. Σε περίπτωση που είναι αργία, πραγματοποιείται την αμέσως προηγούμενη εργάσιμη ημέρα.

The Intraday Auction of Main Market occurs only every 3rd Friday of each month. In case the 3rd Friday is a holiday, it occurs on the previous working day.